

SERVICE MANUAL

SECOH AIR PUMPS

Models covered in this manual:

SLL-20, 30, 40 & 50
EL-60, 80-15, 80-17 & 100
EL-120W, 150 & 200

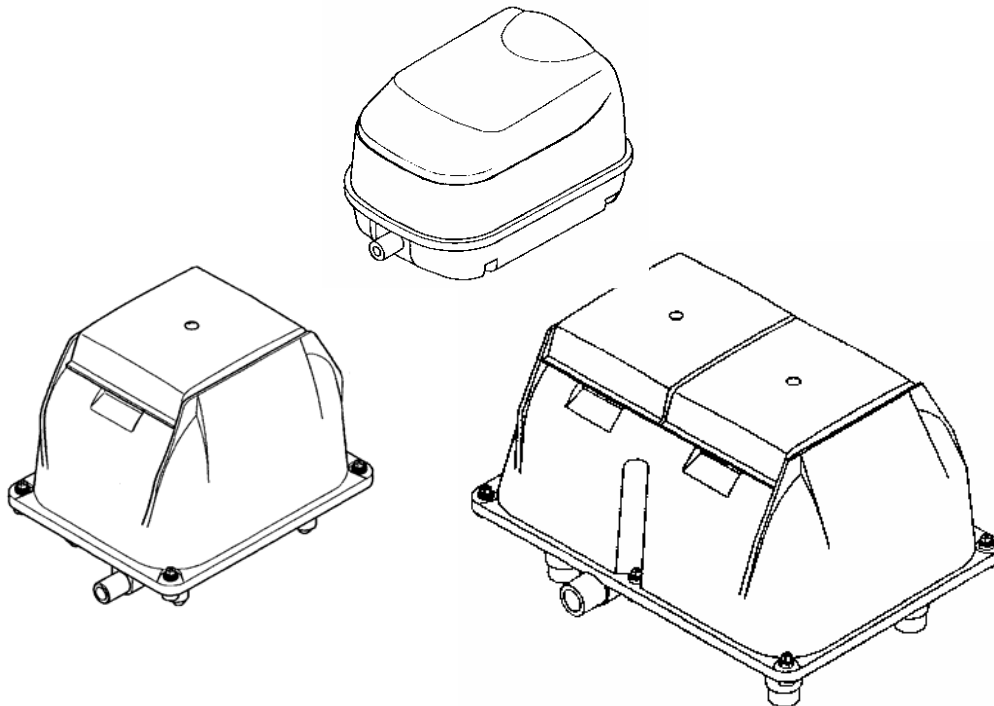

Contents

1. Prior to maintenance and Service
2. Maintenance
3. Air filter cleaning / replacement
4. Valve box and diaphragm replacement
5. Resetting auto stopper
6. Magnet replacement
7. Diagnosis of failures
8. Technical Specification
9. Test data (resistance table)
10. Spares Kits and replacement parts

1. Prior to maintenance and service

- Prior to maintenance and service, read and keep this manual carefully.
- Follow the safety instructions!
- Servicing and maintenance as described in this manual should be carried out by an authorised service facility.



DANGER

- **Always disconnect power supply before servicing. Failure to do so could result in electrical shock, personal injury or death.**
- **Do not touch live parts. Touching live parts will result in electric shock.**

2. Maintenance

❖ **Cleaning the air filter**

The air filter must be cleaned every 3 to 4 months to insure correct operation and replaced regularly.

❖ **Occasional checks**

- Is air blowing out properly?
- Is the air pump making abnormal noise or vibrations?
- Is the temperature of the air pump not abnormally high?
- Is the power cord or plug damaged or discoloured?

→ If any irregularity is found, read DIAGNOSIS OF FAILURES.

3. Filter element cleaning or replacement

a) Undo the truss head screw of the filter cover.

b) Remove the filter cover, by firmly pulling it off.

c) Remove the filter element and brush off any dust particles by hand.

If heavily clogged with dust, wash in a neutral detergent followed by a thorough rinsing in water. Allow to dry in the shade.

Note: Do not use benzene or thinner to clean filter element as it can be damaged!

d) After cleaning reassemble the filter element back in place. Make sure to put the harder side of the filter facing downwards. Press in the filter cover.

e) Secure the filter cover by the truss head screw.

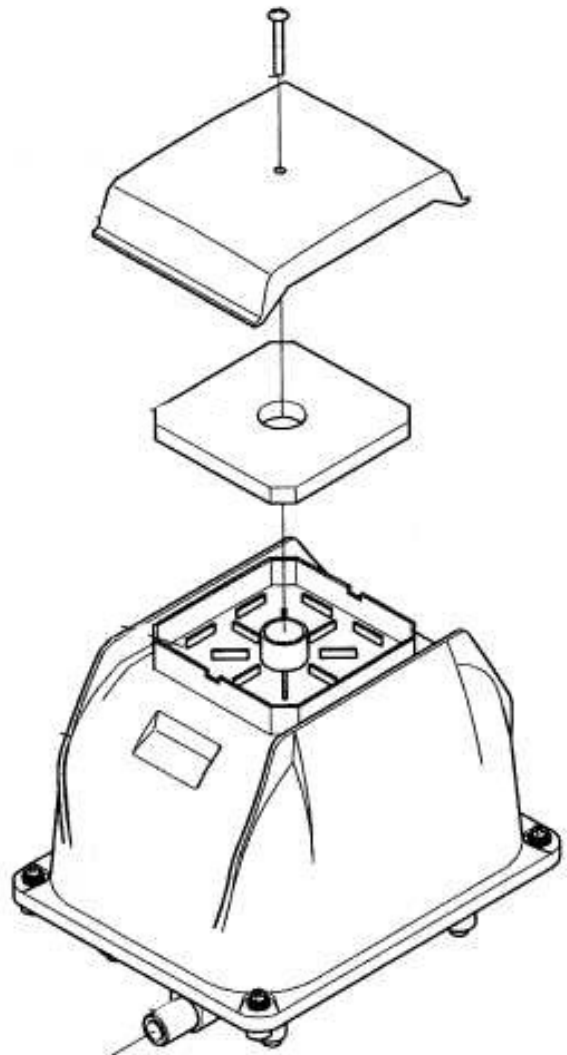

4. Valve box and diaphragm replacement

- a) Undo the 4 corner bolts of the overall cover.
- b) Remove the overall cover. If it is hard to remove, insert a screwdriver in the slot provided.
- c) Pull out the bushing.
- d) Remove the shock absorber

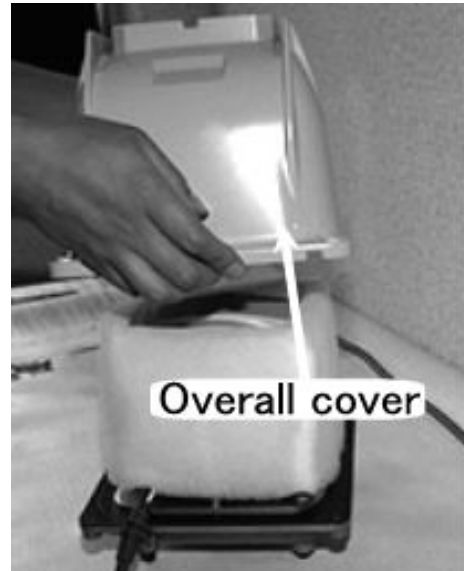

- e) Undo the 4 screws of the holder cover.

Note:
It is easier to change one diaphragm at a time.



- f) Insert the magnet support jig in the 4 corners, between the magnet and the core.

Note: The magnet support jig (carton strips) is included in the service repair kit.

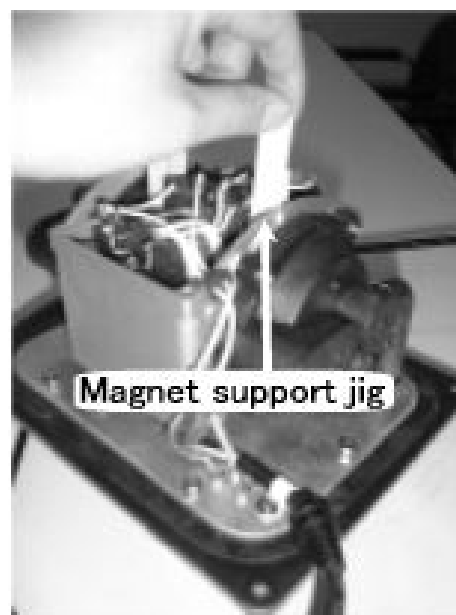

g) Undo the 4 screws of the valve box.

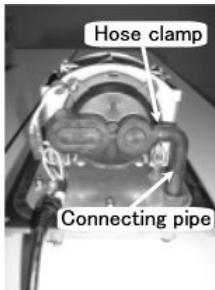

h) Slide down the hose clamp, pull off the connecting pipe and remove the valve box.

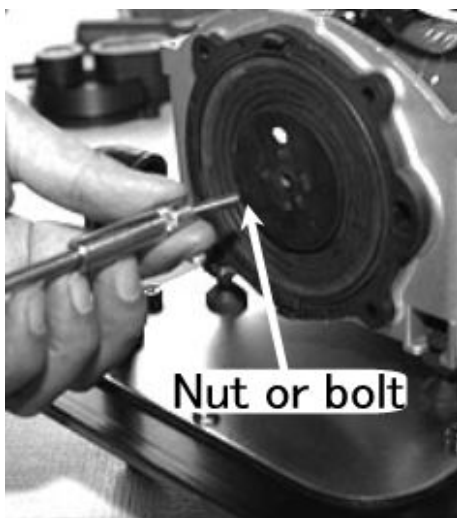
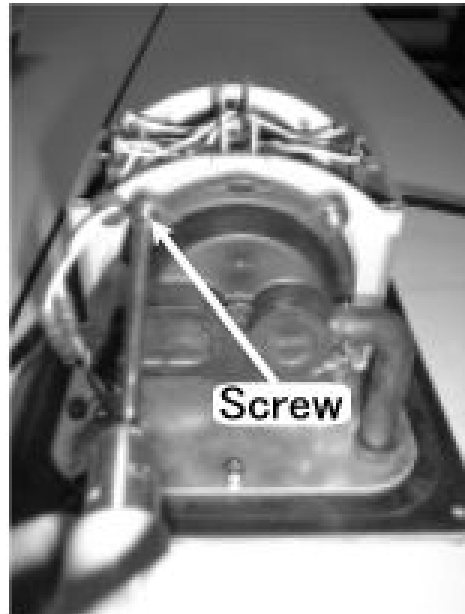

i) Undo the nut or bolt and remove the diaphragm (Nut: SLL series & EL-60, 80-15 & 120W - Bolt: EL-80-17, 100, 150 & 200).

j) Set the new diaphragm and fix it by the nut or bolt (torque, see table at appendix).

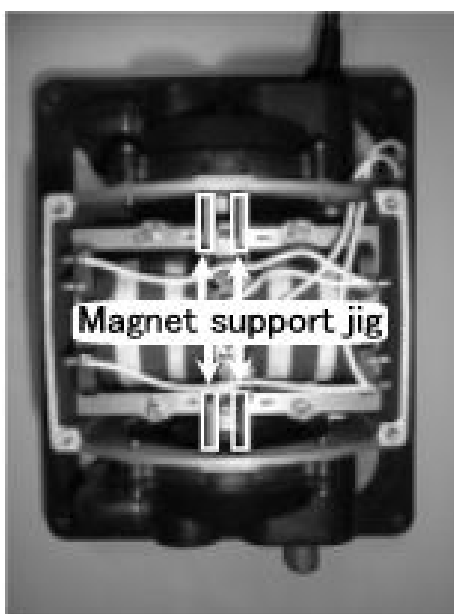

k) Insert the magnet supporter jig in the 4 corners between the magnet and the core.

Note: Make sure that the magnet is in the centre of the solenoids.

l) Install the new valve box and secure into position using the 4 corner screws.

m) Replace opposite diaphragm following the above procedure.

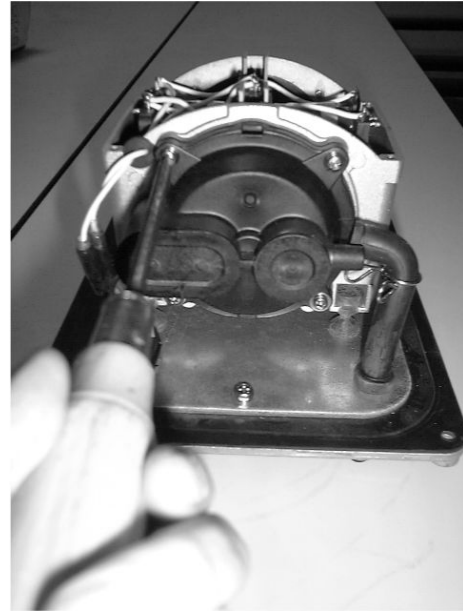
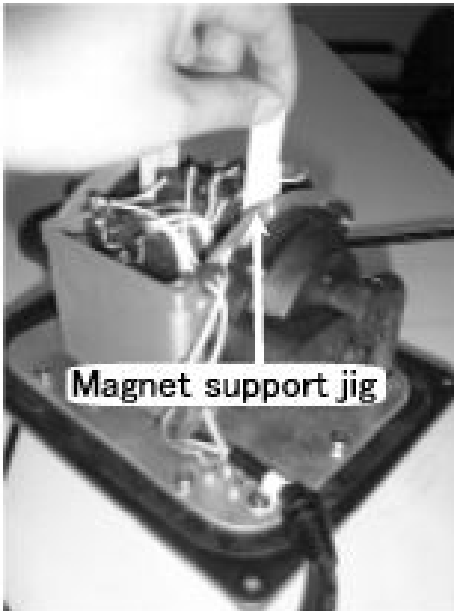

n) Pull out the magnet support jig.

o) Check the magnet is in a central position.

Note: The tolerance of the centring of the magnet is within +/- 0.5 mm (see dimension "d" of sketch in appendix).

p) Push on the connecting pipe and refit the hose clamp.

q) Reset the auto stopper (If necessary)

r) Connect power cord to confirm proper operation.

Danger: Do not touch live parts. Touching live parts will result in electric shock!

s) Fasten the holder cover with the screws.



- t) Put the shock absorber back into place.



- u) Insert the power cord bushing into the location notch.

Note: It locates into the inner slot!

- v) Replace the overall cover and secure by using the nuts and bolts.

- w) Replace air filter as previously described.

Secure filter cover using the truss head screw.



5. Reset auto stopper (protective switch)

Function of auto stopper

A running pump with a broken diaphragm may cause a major break down and excessive repair cost. To prevent this from occurring, EL-series pumps are equipped with a protective switch.

If the diaphragm is broken, the magnet reciprocates with abnormal amplitude and the projection of the magnet hits the slider of the auto stopper. The contact is interrupted and power is cut off.

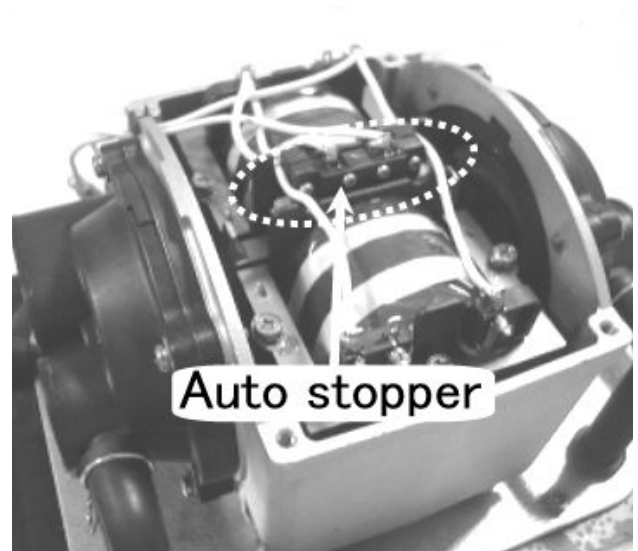

Auto stopper reset

- Follow the procedure of chapter 4 from a) to e)
- Set the slider at the position L1 = L2.
- Follow the procedure of section 4 from point r) to point w).

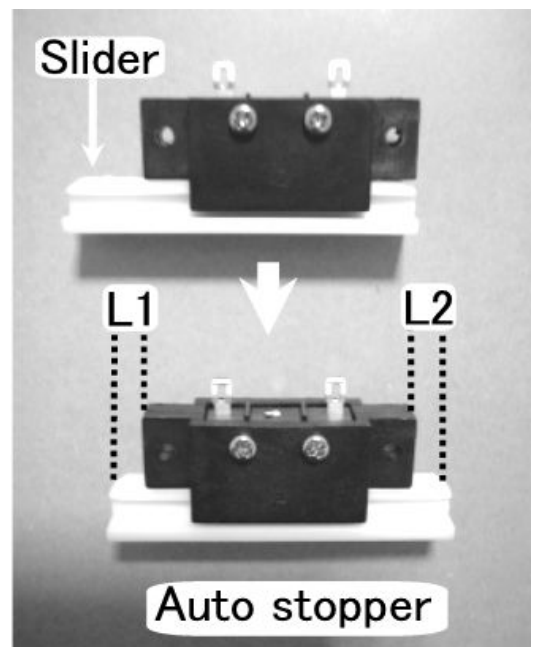

6. Magnet replacement

- a) Follow the procedure of section 4 from a) to i).
- b) Remove diaphragm and pull out opposite diaphragm and magnet from other side.

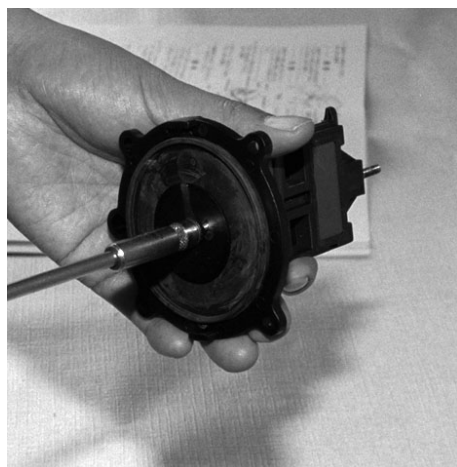
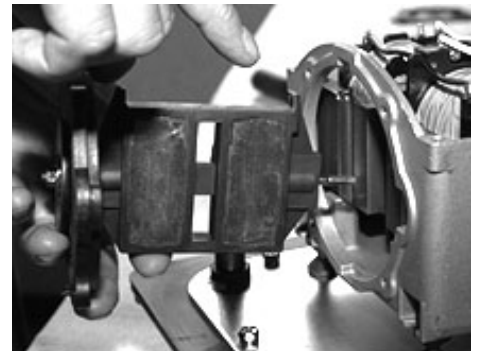

- c) Assemble new magnet and diaphragm with nut or bolt.

- d) Insert the diaphragm and the magnet between the solenoids. The projection should be upward.

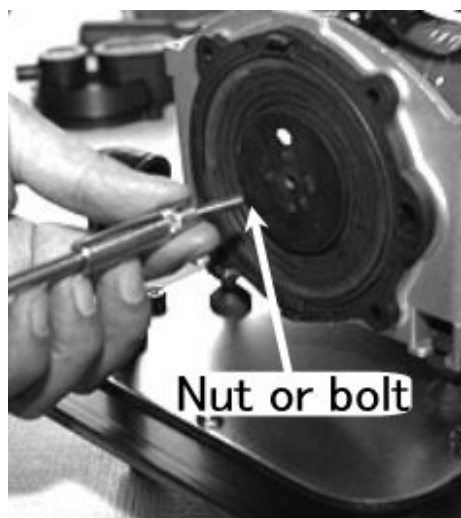
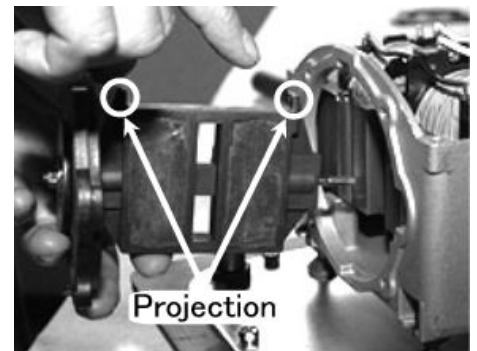

- e) Install replacement diaphragm to opposite side.
- f) Follow the procedure of chapter 4 from k) to w).

7. Diagnosis of Failures

| Problem | Cause | Action |
|--|---|---|
| Pump does not work | Power plug is disconnected | Plug in and check if electricity is available |
| | Cord is broken (Internal wiring damaged) | Check electrical continuity with circuit tester |
| | Auto stopper activated | Open cover to check for damage on diaphragm |
| Excessive noise | Valves or diaphragm are damaged | Open cover to check for damage or disconnection |
| | L-Tube is damaged or disconnected | Re-connect or replace L-Tube |
| | Pump is in touch with surrounding articles. | Re-position pump |
| Discharged air volume decreases | Air filter is clogged | Clean or replace air filter |
| | Air diffuser or pipe is clogged | Clean air diffuser and check piping |
| Abnormal temperature arises | Air filter is clogged | Clean or replace air filter |
| | Air diffuser or pipe is clogged | Un-block air diffuser or pipe |
| Pump sometimes operates and sometimes not. * | Air filter is or diffuser is clogged | Clean or replace air filter or diffuser |

*A decrease in airflow (caused by clogged air filter or air diffuser) may lead to an extraordinary rise in operating temperature. This will activate a thermal protector and stop the pump. When the temperature reduces, the pump will automatically restart.

If in doubt about any service or maintenance procedures, please call partsandpumps.co.uk

8. Technical Specifications

| Model | | SLL-20 | SLL-30 | SLL-40 | SLL-50 |
|----------------------|-------|-------------------------------|---------------|---------------|---------------|
| Voltage | V | As shown in the name plate | | | |
| Frequency | Hz | Applied to 50 | | | |
| Optimal Press. | bar | 0.2 | | | 0.2 |
| Open Flow | L/min | 52 | 60 | 68 | 75 |
| Max Power | W | As shown in the name plate | | | |
| Outlet dia. | mm | OD 19 mm | | | |
| Weight | kg | 4.5 | | | |
| Standard accessories | | L-Joint hose (with hose band) | | | |

| Model | | EL-60 | EL-80-15 | EL-80-17 | EL-100 |
|----------------------|-------|-------------------------------|-----------------|-----------------|---------------|
| Voltage | V | As shown in the name plate | | | |
| Frequency | Hz | Applied to 50 | | | |
| Optimal Press. | bar | 0.2 | 0.2 | 0.2 | 0.2 |
| Open Flow | L/min | 105 | 115 | 120 | 145 |
| Max Power | W | As shown in the name plate | | | |
| Outlet dia. | mm | OD 19 mm | | | |
| Weight | kg | 8.5 | | | |
| Standard accessories | | L-Joint hose (with hose band) | | | |

| Model | | EL-120W | EL-150 | EL-200 |
|----------------------|-------|-------------------------------|---------------|---------------|
| Voltage | V | As shown in the name plate | | |
| Frequency | Hz | Applied to 50 | | |
| Optimal Press. | bar | 0.25 | | |
| Open Flow | L/min | 225 | 265 | 310 |
| Max Power | W | As shown in the name plate | | |
| Outlet dia. | mm | OD 27 mm | | |
| Weight | kg | 16 | | |
| Standard accessories | | L-Joint hose (with hose band) | | |

9. Testing Data

a) Solenoid resistance table

Voltage: 230V, 50Hz

Tolerance: +/- 10%

SLL-20 & 30 models: Solenoids are in series connection

Other models: Solenoids are in parallel connection

| | Total R | Single R |
|-----------------|----------------|-----------------|
| SLL-40 | 86.5 | 173.0 |
| SLL-50 | 60.8 | 121.7 |
| EL-60 | 36.7 | 73.4 |
| EL-80-15 | 21.9 | 43.7 |
| EL-80-17 | 33.1 | 66.2 |
| EL-100 | 20.0 | 40.0 |
| EL-120W | 16.2 | 64.7 |
| EL-150 | 16.6 | 66.2 |
| EL-200 | 10.0 | 40.0 |

10. Spare Part Kits

Only use genuine SECOH replacement parts. Non-standard parts will have a detrimental effect on overall pump life and performance.

In order to ensure long service and operation, it is recommended diaphragms and valve boxes are replaced once a year.

All parts; magnets, filters, service kits and diaphragms are available from www.partsandpumps.co.uk online site and can be despatched immediately.

We also stock a complete range of Secoh pumps for replacement purposes and these can also be used to replace defective pumps of other brands with ease.

| SLL SERIES | | | | | | | | |
|----------------------|--|----------------------|-----|--------|------------------|------------------|--------|----------------|
| Kit Name | Part No. Code | Contents | | Pos No | Required kit Qty | | | |
| | | Parts included | Qty | | SLL20 | SLL30 | SLL40 | SLL50 |
| Diaphragm repair kit | K-SLL-D EM-0359025 | Diaphragm | 2 | 10 | 1 | 1 | 1 | 1 |
| | | Diaphragm holder | 2 | 9 | | | | |
| | | Nut | 2 | 24 | | | | |
| | | Valve box & valve | 2 | 11 | | | | |
| | | Filter element | 1 | 3 | | | | |
| | | Filter cover packing | 1 | 2 | | | | |
| | | Tank base packing | 1 | 17 | | | | |
| Magnet | K-SLL-M EM-0351008 | Magnet | 1 | 8 | 1 | 1 | 1 | 1 |
| | | Nut | 2 | 24 | | | | |
| EL SERIES | | | | | | | | |
| Kit name | Part No. Code | Contents | | Pos No | Required kit Qty | | | |
| | | Parts included | Qty | | EL60 EL80-15 | EL80-17 EL100 | EL120W | EL150 EL200 |
| Diaphragm repair kit | K-EL-D EM-0377007 | Diaphragm | 2 | 11 | 1 | 1 | 2 | 2 |
| | | Diaphragm holder | 2 | 10 | | | | |
| | | Nut | 2 | 23 | | | | |
| | | Valve box & valve | 2 | 12 | | | | |
| | | Filter element | 1 | 2 | | | | |
| Magnet | K-EL60,80-15-M EM-0374008 | Magnet | 1 | 9 | 1 | | 2 | |
| | | Nut | 2 | 23 | | | | |
| | K-EL80-17,100-M EM-0405000 | Magnet | 1 | 9 | | 1 | | 2 |
| | | Screw | 2 | 23 | | | | |
| Auto stopper | S-EL60,80-15,120W EM-0433004 | Auto stopper | 1 | 6 | 1 | | 2 | |
| | S-EL80-17,150,200 EM-0434000 | Auto stopper | 1 | 6 | | 1 | | 2 |